



Ocean Exploration Advisory Board Meeting

February 23, 2017

Developments in Autonomous Vehicles

Thomas Chance

CEO, ASV Global

Thomas.Chance@ASVglobal.com

ASV unmanned
marine systems



Overview of Presentation (Open Discussion)

- **AUV technology and operations (short)**
 - **ASV technology and operations**
- 

AUV Technology and Operations

- **As former owner of C & C Technologies / AUV service company**
- **Shallow water AUVs**
 - **Limited / Not too practical**
- **Deep water AUVs**
 - **Similar cost & complexity to large ROVs**
 - **Need dedicated team and large spares set**
 - **AUV constrained by energy and positioning**
 - **Great for pre-planned regional data collection**
 - **Not great for real time control**
 - **Launch & Retrieval should not be underestimated**
 - **Assume a \$5m to \$8m investment for AUV/LARS/Spares**
 - **Multiple AUVs simultaneously from one ship is challenging**

ASV / USV Technology and Operations

- **Currently owner of ASV Global, LLC**
 - **What ASVs can do now**
 - **ASVs – Two years out**
 - **Game Changers and Challenges**
 - **Overview of ASV Global vehicles**
 - **Launch and Retrieval**
 - **Payloads**
- 



- **ASV Global designs, builds, sells, leases, and supports ASVs**
- **Founded in 2010, 85 Employees, Offices in US and UK**
- **Provide ASVs for Commercial and Military Applications Worldwide**
- **Unmanned & Optionally Manned New Builds, Conversions**
- **Delivered over 80 systems from 6' to 42' in length**
- **Powered by Diesel, Solar, Wind, Battery; Endurance up to 60 days**
- **Supervised Autonomous Operations w/ Radio Telemetry or Satellite**
- **Advanced Payloads, LARs, Reliability, Collision Avoidance / COLREGS**

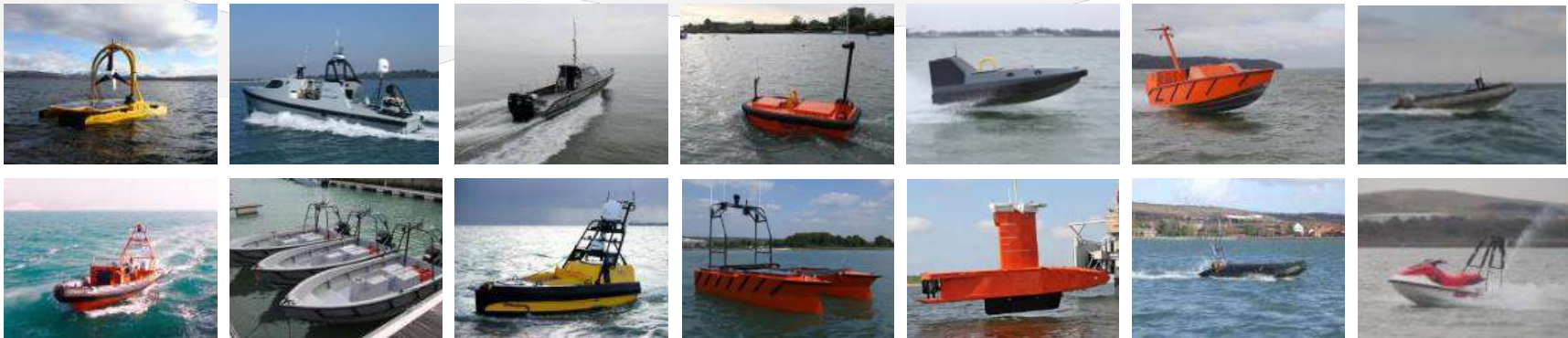

ASV / USV Technology and Operations

What ASVs can do now...

- **Fixed sensors (including retractable ram applications)**
 - **Single beam echosounder**
 - **High frequency shallow multibeam**
 - **Hull mounted side scan / subbottom profiler**
 - **Acoustic Doppler current profiler (ADCP)**
 - **Acoustic comms**
 - **Acoustic fish count**
 - **Ultra-short baseline positioning (USBL)**
 - **Fixed chemical sensors**
 - **Fixed biological sensors**
 - **Above water laser (point cloud) systems**
 - **Meteorological systems**
 - **Radar surveillance**

ASV / USV Technology and Operations

What ASVs can do now...

- CTD profiles
- Passive Acoustic Monitoring
- Lowered chemical sensors (O₂ / hypoxia monitoring)
- Lowered biological sensors (chlorophyll, etc.)
- Towed side scan sonar / subbottom profiler
- Towed magnetometer
- Some lowered water samplers
- Helikite (above water – camera)
- Small oil spill boom
- Fire suppression (water, foam, or dry chemical)

Note: Pole mounted sensor applications are more developed than winch deployed systems.

ASV / USV Technology and Operations

ASV Capabilities – 2 years out

- Mid frequency multibeam sonars
- Small ROV systems (observation class)
- Launch drifter buoys
- Lower and release sensors onto the bottom
- Deploy oil spill dispersant
- Deploy and recover certain AUVs & buoyancy gliders
- Deploy wave gliders
- Deploy and recover certain UAVs
- Operate globally over the horizon (telepresence)
- Transit and anchor (temporary buoy replacement)
- Move cargo from A to B
- First larger ship will be operating reduced manned
- Operate in more congested areas

ASV / USV Technology and Operations

Game Changers in the ASV industry

- Industry and government investment
- New satellite comms systems
 - Iridium Next
 - Inmarsat Global Express
 - Intelsat Epic
- Seakeeper gyro stabilization

Challenges in the ASV industry

- No rules / potential for over constraining rules
- Maritime unions
- Un-charted legal area
- Massive glut in industrial vessel market (cheap alternatives)

Commercial and Scientific

C-Stat 2
2 built

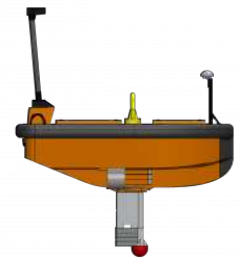

C-Cat 3
1 built

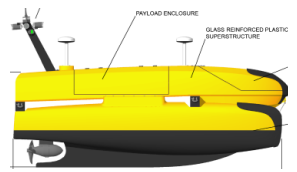

C-Enduro 3
3 built

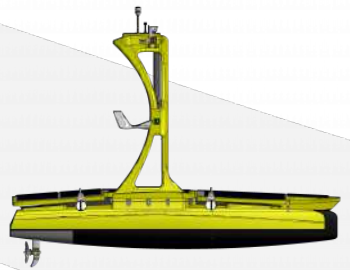

C-Worker 4
1 built



C-Worker 5
4 built

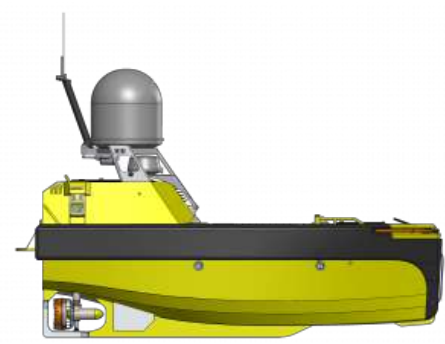
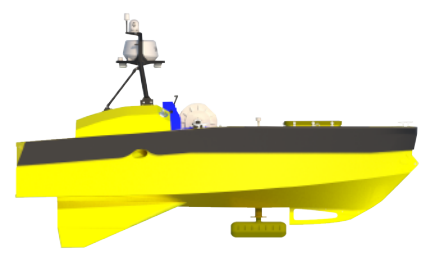

C-Worker 6
2 built
1 in build



C-Worker 7
2 in build



C-Worker 8
6 in build

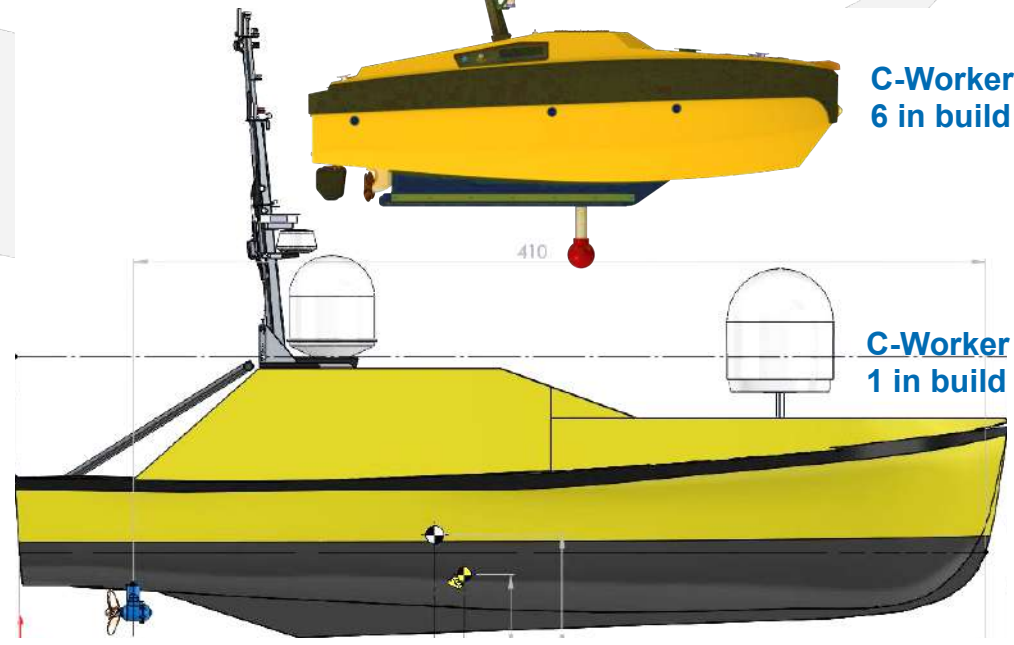

C-Worker 12
1 in build

Military and Security

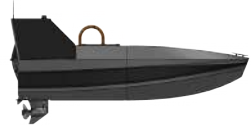

C-Target 3
2 built

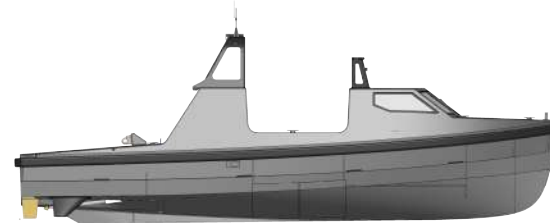

Halcyon
1 built



C-Target 6
21 built

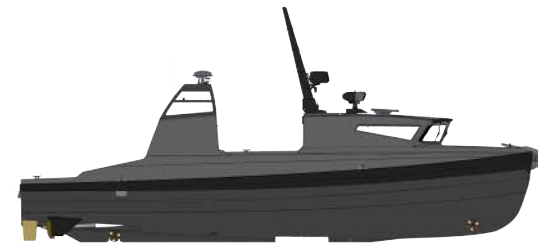

Halcyon Mk II
2 in build

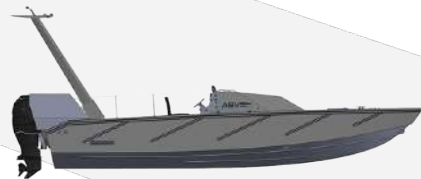

C-Target 9
6 built



C-Target 13
6 built



15m MMCM
Designed

These USVs are not detailed in this document. Information is available upon request

Standard Features

Base Systems / Standard Features

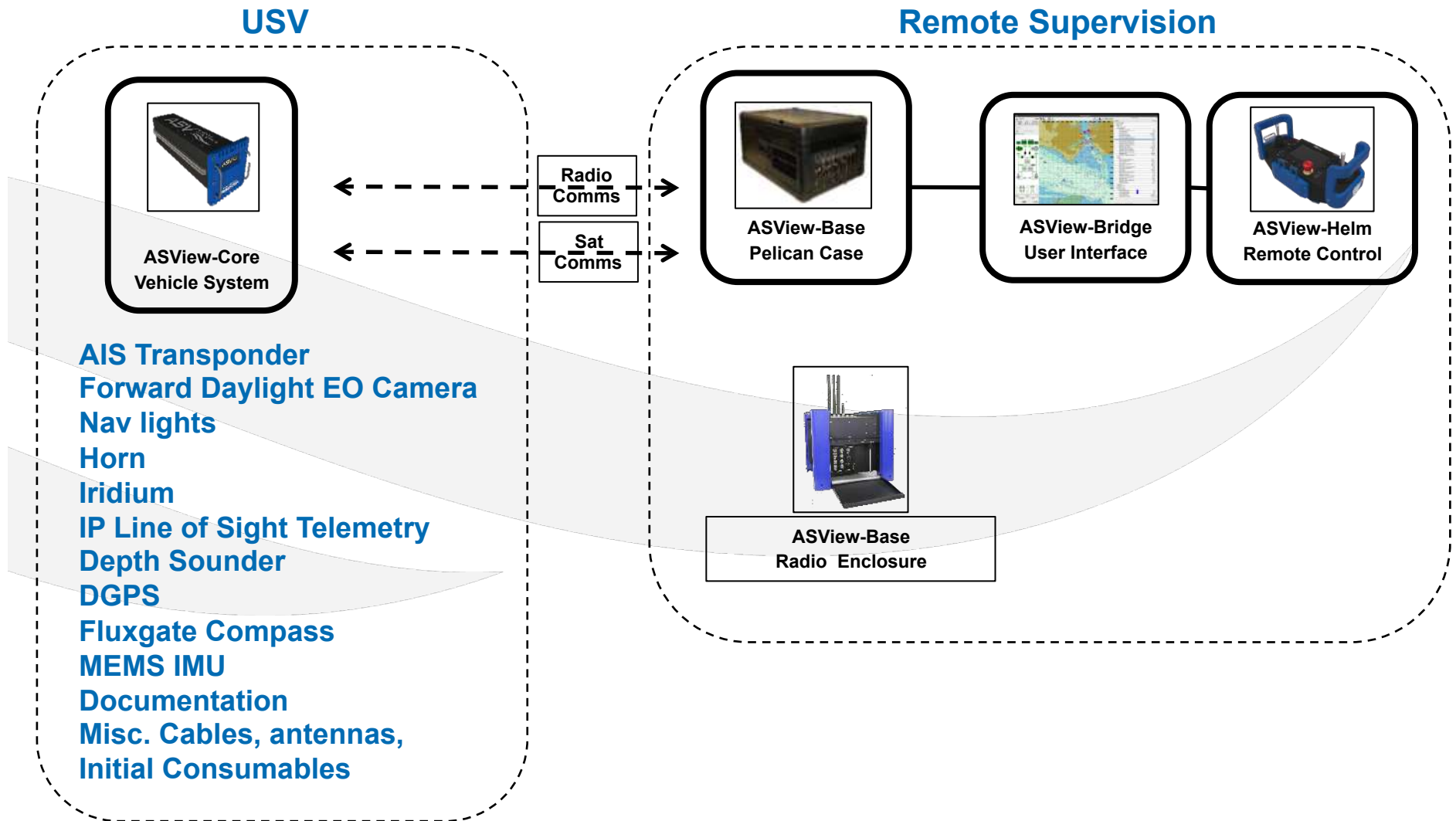

Payload Control / Supervised Autonomy

- ASV Operations Supervised from:
 - Mothership via 20km Radio Link or
 - Shore via VSAT Satellite Link

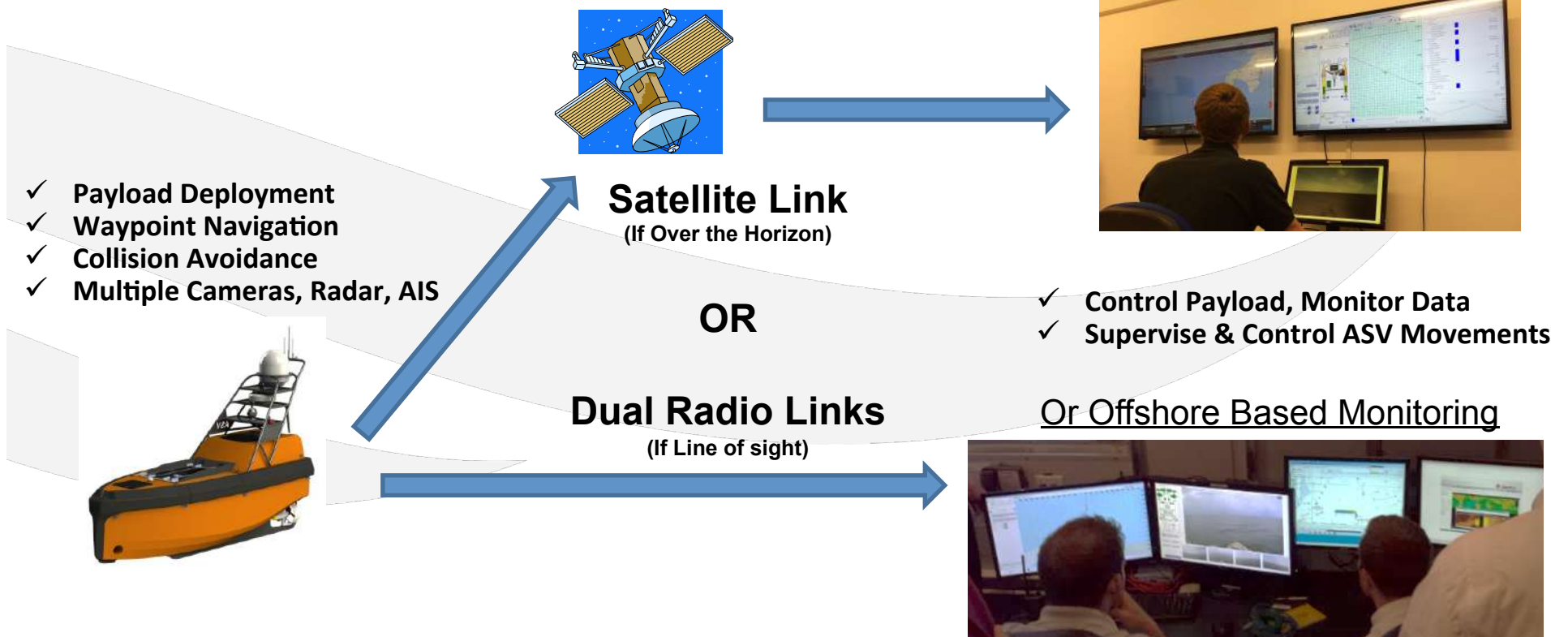

ASView – Vehicle Control System - UI



Machine Vision Feedback

Infrared PTZ camera view and control

Critical Data Display

Main Display
Clear navigation data

Vehicle Data Display

- Full S57 ENC's displaying
- Vessel position and heading
- Vessel track
- AIS targets from receiver on USV
- Radar overlay
- Mission plans
- Configurable camera displays and controls

ENC Charts

ASV Position

AIS Target



Radar view

Multiple cameras

Collision Avoidance Software

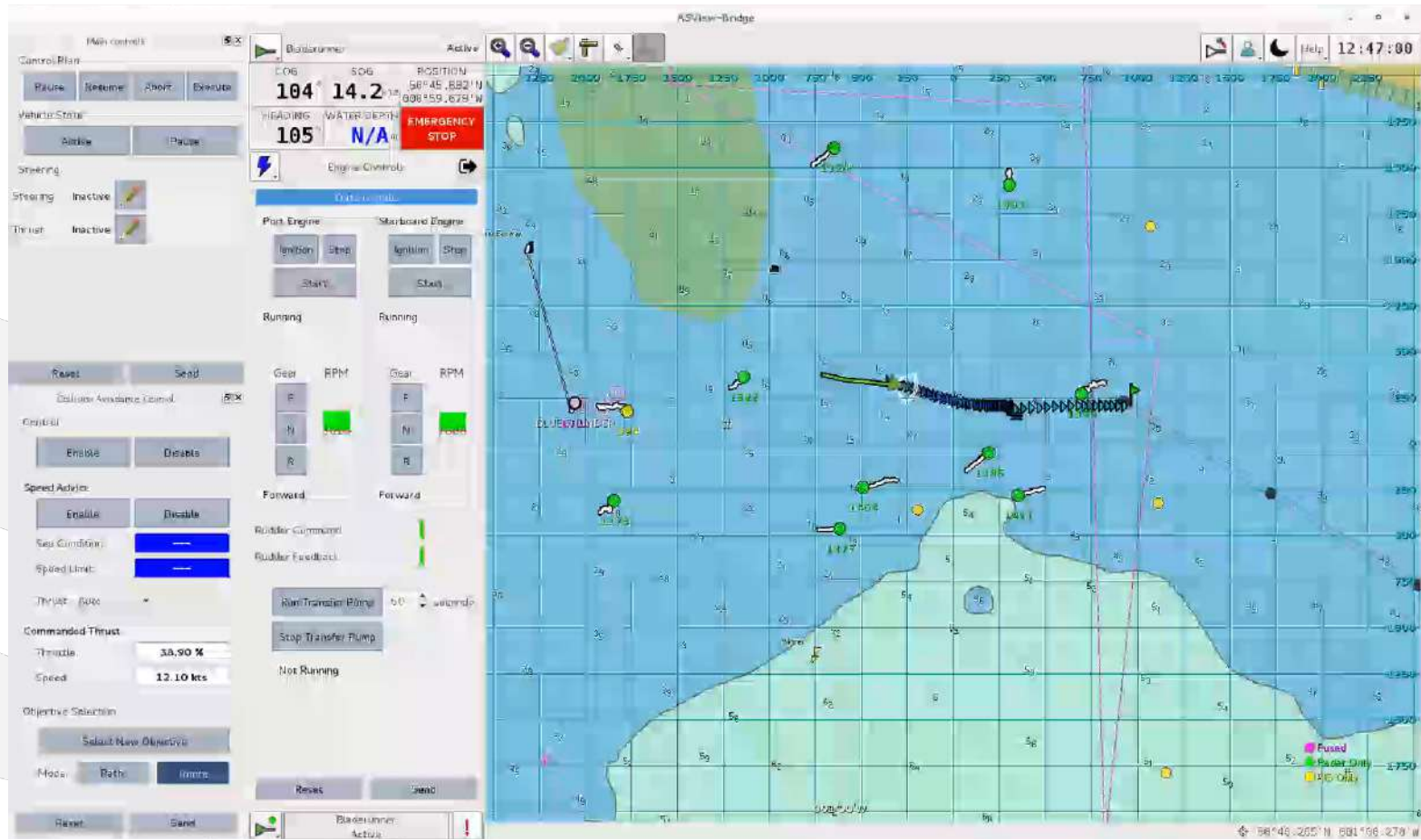

Optional Items

Situational Awareness Package

- Radar
- Daylight 360 EO System*
- Forward IR

Advanced Situational Awareness Package

- Radar
- Daylight 360 EO System*
- Nighttime 360 IR System*
- Millimeter Wave Solid State Radar

Collision Avoidance Software Packages

- AIS
- Radar
- Camera*

Advanced Spares Packages

Satellite Communications Systems

- Single
- Dual*

Other Optional Items:

- Boat Trailer
- Boat Cradle
- LARS
- Active Radar Reflector
- Hailing system
- Voice over IP VHF
- Custom Payload Integration
- Training Packages
- Field Operational Support
- Mission Control Monitoring Services
- Mission Control Room
- Payload Integration
- Payload Winch
- Articulating Transducer Ram
- Articulating A-Frame

* Available in 4th quarter 2017

C-Stat 2 (2.4m / 8')

Primary Advantages: Station Keeping Buoy, 4 day Endurance Holding Station, Interchangeable Payload, Transducer Ram, Larger Versions available with Weeks of Endurance and Optional Anchor. Base price of \$90k.

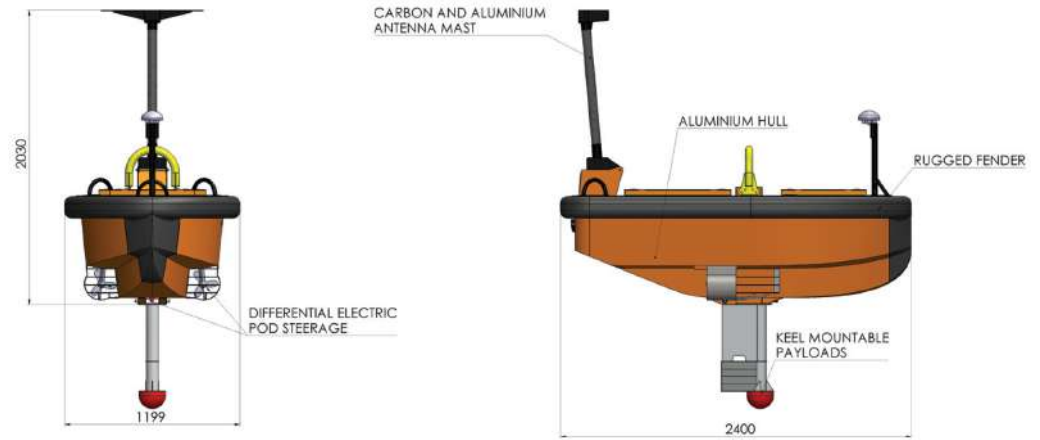

Base Specs	C-Stat
Length:	2.4m
Beam:	1.2m
Height:	1.7m
Draft*	0.7m
Weight	450kg lightship
Propulsion:	Diesel generator, battery and 2 x DC thrusters
Speed:	Up to 3.7 knots
Approximate endurance and range:	4 days @ 1.8 knots = 172 NM 2 days @ 2.8 knots = 134 NM
Fuel capacity:	75 liters
Payload capacity (weight, power):	20kg, 300w



C-Cat 3 (2.4m / 8')

Primary Advantages: Very Shallow Draft, Fits in a Pickup Truck, Endurance up to 6 hours with Lithium Battery Pack, Speeds up to 5 knots, Supports Various Payloads, Elastomer Coated Closed Cell Foam Hulls. Base price \$90k.

Base Specs	C-Cat 3
Length:	2.86m
Beam:	1.46m
Height:	1.37m
Draft*	0.27m
Weight	Lightship 185kg, fully laden 235kg
Propulsion:	2 x DC electric motors driving 3 blades propellers
Speed:	Up to 6 knots
Approximate endurance and range:	4.5 h @ 3 knots = 13.5 NM 1.5 h @ 5 knots = 7.5 NM
Range at slow speed:	15nmi
Fuel capacity:	n/a
Payload capacity (weight, power):	~50kg

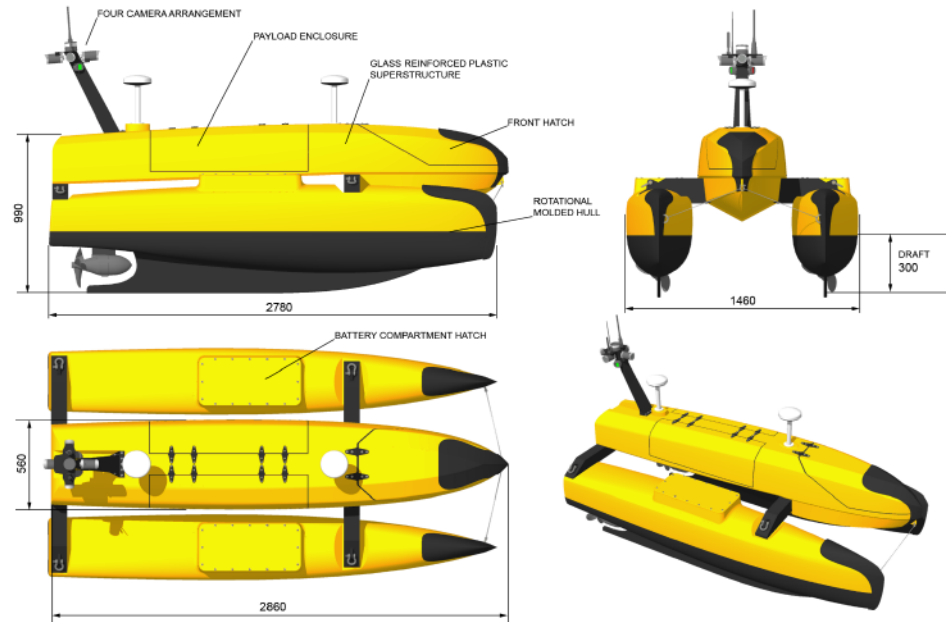

The C-Cat 3 is an evolution of the successful C-Cat 2

C-Worker 4 (4m / 13')

Primary Advantages: Small Size, 2 day Endurance at 3 knots, Shallow Draft Jet Drive, Interchangeable Payload, Transducer Ram. Base price \$390k.

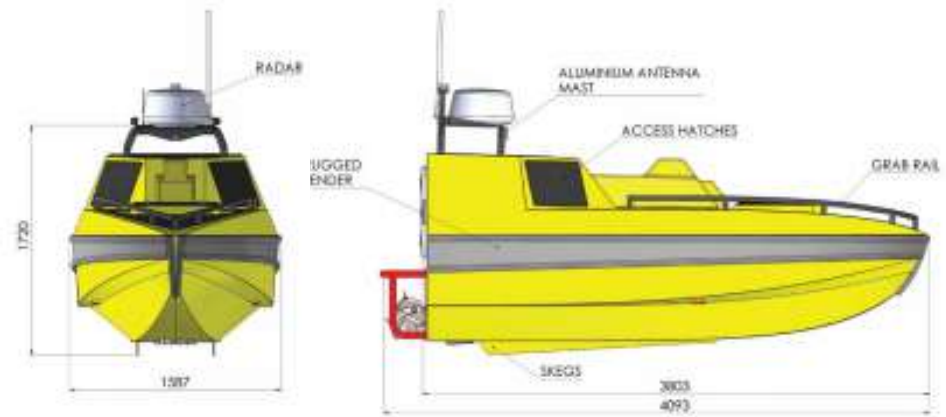

Base Specs	C-Worker 4
Length:	4.17m
Beam:	1.58m
Height:	0.4m
Draft*	2.026m
Weight	786kg lightship
Propulsion:	30HP Marine diesel engine driving waterjet
Speed:	Up to 6.5 knots
Approximate endurance and range:	2 days @ 3 knots = 144 NM 0.5 days @ 6 knots = 72 NM
Range at slow speed:	150nmi
Fuel capacity:	100 liters
Payload capacity (weight, power):	30kg, 500w 19" rack 8U's Moonpool 0.8x0.59x0.5m (LxWxD)



C-Cat 4 (4.3m / 14')

Primary Advantages: Shallow Draft, Endurance up to 48 hours with Diesel Generator, Speeds up to 6 knots, Supports Various Payloads, Collapses into a Standard 20' Shipping Container. Base price \$450k.

Base Specs	C-Cat 4
Length:	4.3m
Beam:	2.9m
Height:	2.5m
Draft*	0.6m
Weight	850 kg lightship
Propulsion:	Diesel generator w/ dual electric propulsion
Speed:	Up to 6 knots
Approximate endurance and range:	2.5 days @ 4 knots 6 days @ 2 knots
Range at slow speed:	
Fuel capacity:	
Payload capacity (weight, power):	

C-Cat 4 performing water quality monitoring in Japan.



C-Worker 5 (5.5m / 18')

Primary Advantages: Force Multiplier, Interchangeable Payload, Winch Bay, Transducer Pole, Direct Drive Diesel, 30% Smaller than Manned Launch, trailerable. Base price \$490k.



Base Specs	C-Worker 5
Length:	5.5m
Beam:	1.7m
Height:	0.9m
Draft*	1.8m
Weight	2100kg
Propulsion:	Direct driver fixed propeller 1 x Yanmar 57hp diesel engine
Speed:	Up to 9 knots
Approximate endurance and range:	14 days @ 3.5 knots = 1760 NM 5 days @ 6 knots = 720 NM
Fuel capacity:	800 liters
Payload capacity (weight, power):	800w

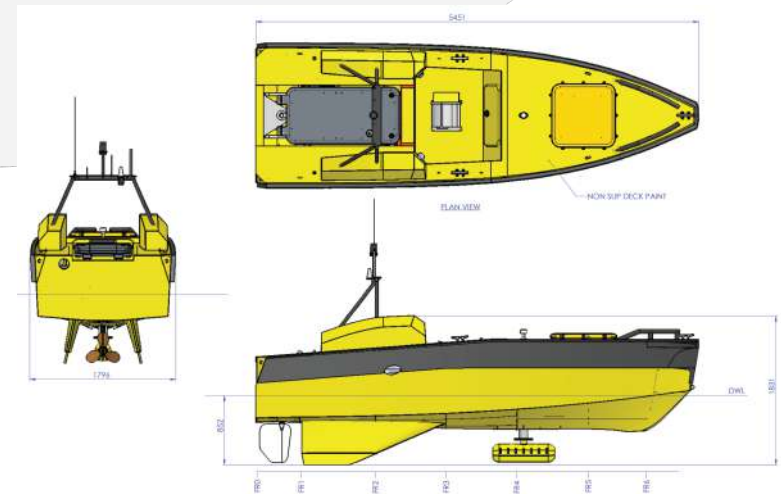

C-Worker 6 (5.8m / 19')

Primary Advantages: Endurance up to 25 days, Potential for Over the Horizon Capabilities (monitored over VSAT), 1m x 1.5m Payload Moonpool, 1 kw Payload Power, Dual Redundancy, Diesel Electric Propulsion, Ships in 20' Container, Trailerable. Optional Retractable Rams, Sensor Winch, & Anchor. Base price \$1,190k.

Base Specs	C-Worker 6
Length:	5.8m
Beam:	2.2m
Height:	4.75m or 2.2m with mast folded
Draft*	0.9m
Weight	3200kg lightship
Propulsion:	2 diesel generator sets driving 2 electrical pods via battery bank
Speed:	Up to 5 knots
Approximate endurance and range:	25 days @ 3 knots = 1800 NM 15 days @ 4 knots = 1440 NM
Fuel capacity:	1000 liters
Payload capacity (weight, power):	1kW, 350 kg; Moonpool 1.5x1.0x1.1m (LxWxD)



C-Worker 7 (7.2m / 24')

Primary Advantages: Over the Horizon Capabilities (monitored over VSAT), Endurance up to 30 days, 1m x 2.5m Payload Moonpool, 2kw Payload Power, Dual Redundancy, Diesel Electric Propulsion, Trailerable. Optional Retractable Rams, Sensor Winch, & Anchor. Base price \$1,390k.

Base Specs	C-Worker 7
Length:	7.2m
Beam:	2.3m
Height:	4.2m
Draft*	0.9m
Weight	3750kg lightship
Propulsion:	2 x20 kW diesel generator driving 2 electrical pods via battery bank
Speed:	Up to 6knots
Approximate endurance and range:	30 days @ 3 knots = 1800 NM 18 days @ 4 knots = 1440 NM
Fuel capacity:	1200 liters
Payload capacity (weight, power):	Up to 2 kW, 500kg; Moonpool 2.5x1.0x1.1m (LxWxD)



C-Worker 8 (7.6m / 25')

Primary Advantages: Force multiplier for AUV & multibeam operations, dual direct drive diesel propulsion, dual cone & bullet latching system for dual davit launch and recovery from host surface vessel, trailerable. Base price of \$790k.

Base Specs	C-Worker 8
Length:	7.7m
Beam:	2.15m
Height:	4.3m
Draft*	1.0m
Weight	4900kg
Propulsion:	Twin Yanmar 4JH45 (45 hp) Diesel Twin Fixed Propellers
Speed:	Up to 8 knots
Approximate endurance and range:	8 days @ 4 knots = 768 NM 4 days @ 6 knots = 576 NM
Fuel capacity:	1260 liters
Payload capacity (weight, power):	1kW, 200kg

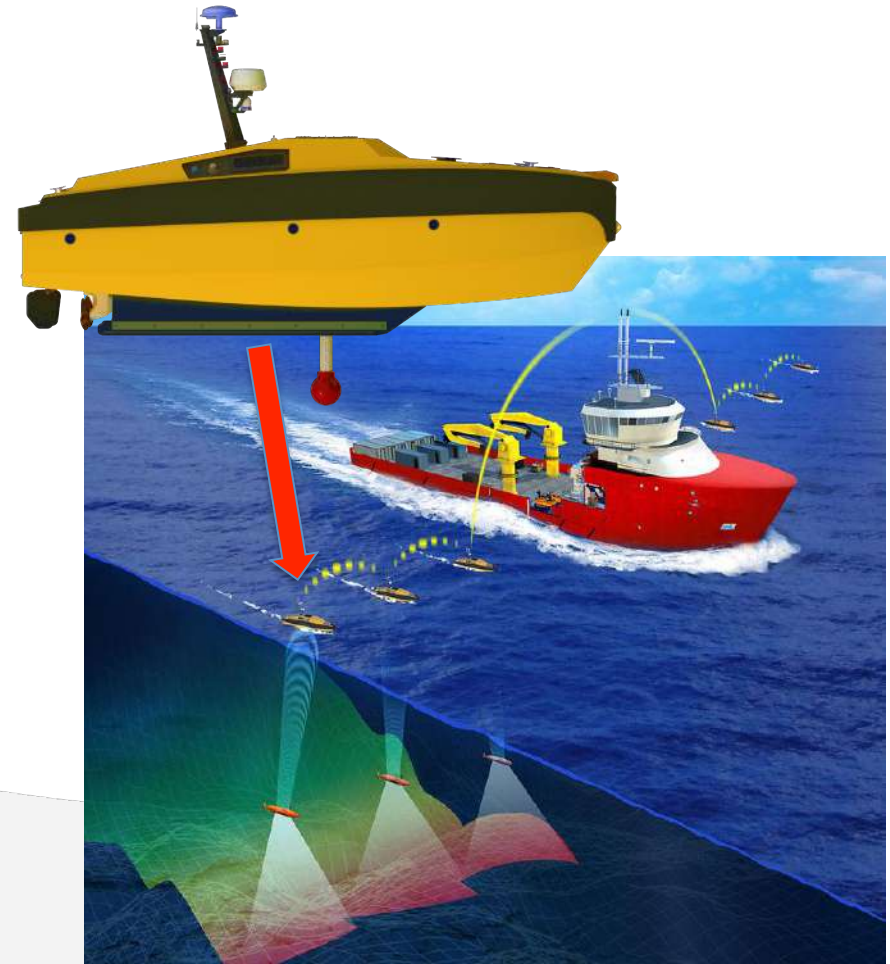

Six C-Worker 8 USVs are under construction, and are scheduled for delivery in Q2 2017

C-Worker 12 (12m / 40')

Primary Advantages: Over the Horizon Capabilities (monitored over VSAT), Endurance up to 35 days, Dual 0.5m x 1m Payload Moonpools, 8 kw Payload Power, Hydraulic Power, Dual Redundancy, Road Trailerable in the USA. Optional Retractable Rams, Sensor Winch, & Anchor. Base price \$1,950k.

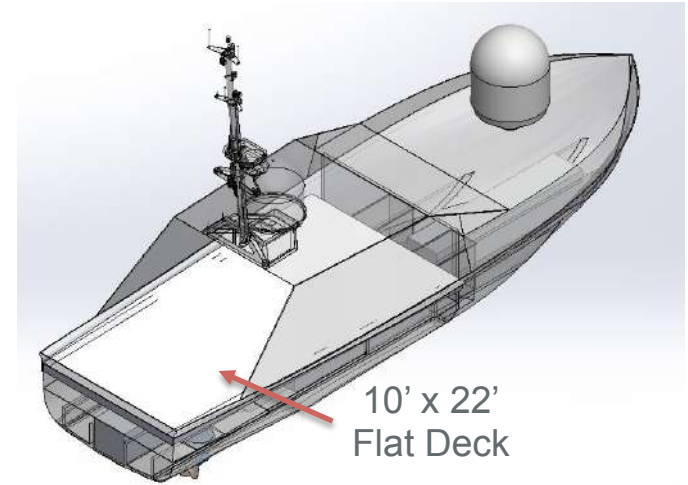

Base Specs	C-Worker 12P
Length:	12.1m
Beam:	3.6m
Height:	3.5m
Draft*	1.16m max
Weight	8850 kg
Propulsion:	Dual Yanmar 4JH110 Diesel Engines with dual Olympic Z-Drives
Speed:	Up to 9 knots
Approximate endurance and range:	35 days @ 4 knots = 3360 NM 14 days @ 7 knots = 2352 NM 7 days @ 9 knots = 1512 NM
Fuel capacity:	5,550 liters
Payload capacity (weight, power):	4000 Pounds, 8 kw

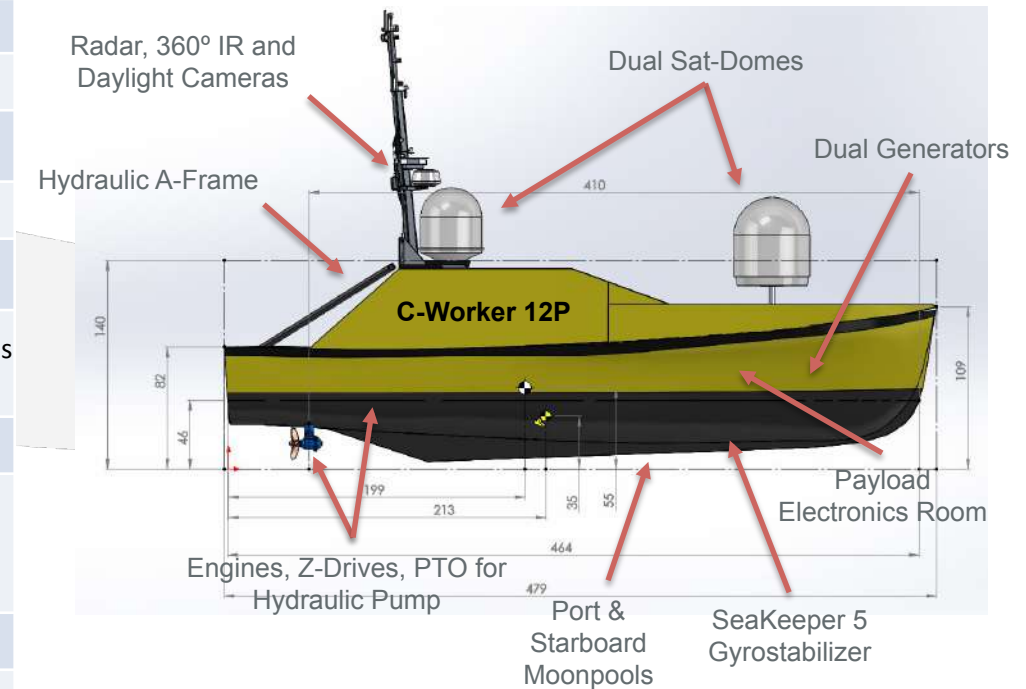

C-Enduro (4.2m / 14')

Primary Advantages: Diesel, Solar, and Wind Powered, Endurance 30+days, Over the Horizon Capabilities (monitored over Iridium), Large Payload Capacity. Base price of \$490k.

Base Specs	C-Enduro
Length:	4.2m
Beam:	2.4m
Height:	2.8m (including antennae), 1.5m (mast off)
Draft*	0.4m
Weight	350kg lightship
Propulsion:	2 x DC Electric brushless motors, solar, wind, diesel
Speed:	Up to 6 knots
Approximate endurance and range:	30+ days @ 2 knots = 1440 NM 3 days @ 6 knots = 432 NM
Fuel capacity:	90 liters
Payload capacity (weight, power):	35kg, 300w peak, 50w continuous



Other ASVs...



Payloads Operated to Date

- Single Beam Echo Sounder (Odom CV100, numerous others)
- Multi-beam Echo Sounder (Kongsberg 2040, R2sonic, Teledyne MB1, Edgetech 6205)
- Ultra Short Baseline Positioning System (Sonardyne Lodestar GyroUSBL)
- Sidescan (Edgetech 4200, Edgetech 4125, Tritech Starfish)
- Acoustic Doppler Current Profiler (Teledyne RDI and Nortek)
- Passive Acoustic Monitor arrays (various)
- Conductivity, Temperature, & Depth (various)
- Acoustic Fish Tracking (Vemco)
- Wetlabs Triplet Puck (Chlorophyll, Dissolved Oxygen, Fluro.)
- Inspection ROV (Saab Seaeye Falcon)
- Acoustic Modem (various)
- Helikite w/ Camera
- Meteorological (wind speed, pressure, temperature, humidity)
- Laser (Renishaw Dynascan, Velodyne)
- Oil Spill Boom Towing
- Oil Spill Dispersant Application

Interest in...

- Small Seismic Compressor
- Hull Mounted & Towed Subbottom Profiler
- Magnetometer & Gradiometer Surveys
- UAV Deployment & Recharge
- Buoyancy Glider Deployment & Recovery
- Mid-Frequency Multibeam to 1000m
- Remote Tide Modelling
- UUV Deployment & Recovery
- Drifter Buoy Deployment
- ROV Operations
- Sonardyne Blue-comm LED Modem
- Fire Suppression Foam Application

ASV unmanned
marine systems

www.asvglobal.com

Thomas Chance
CEO, ASV Global
Thomas.Chance@ASVglobal.com

